



Comprehensive[®]
Connectivity Company

The Pro's Connectivity Since 1974

CHE-HDBT2010

Pro AV/IT 4K (18Gbps) HDBaseT™ Extender Kit,
70m with PoE, RS232, HDCP 2.2



User Manual

Thank you for purchasing this product

For optimum performance and safety, please read these instructions carefully before connecting, operating or adjusting this product. Please keep this manual for future reference.

Surge protection device recommended

This product contains sensitive electrical components that may be damaged by electrical spikes, surges, electric shock, lightning strikes, etc. Use of surge protection systems is highly recommended in order to protect and extend the life of your equipment.

Table of Contents

| | |
|--|-----------|
| 1. Introduction..... | 4 |
| 2. Features..... | 4 |
| 3. Package Contents..... | 5 |
| 4. Specifications | 5 |
| 5. Operation Controls and Functions | 7 |
| 6. Connection Diagram | 11 |

Caution

This extender uses UTP termination, which follows the standard of direct interconnection method as shown below

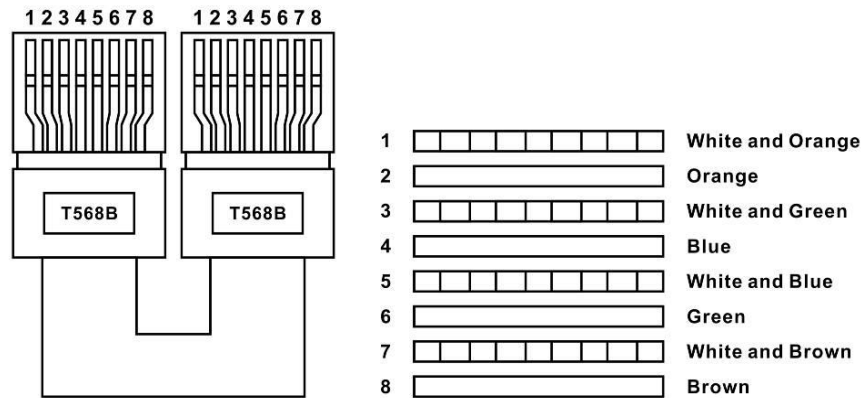

Direct interconnection method

Advanced

The extender will start protection mode automatically when using UTP termination, which follows the standard of cross interconnection method as below.

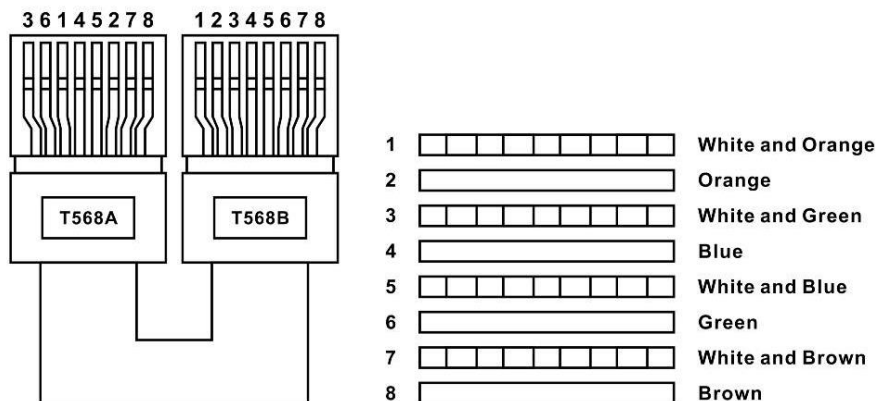

Cross interconnection method

1. Introduction

The 18Gbps HDMI Extender is a tool which can extend an HDMI signal over 230fts/70meters to a compatible display. It is designed to convert HDMI signal to a standard HDBaseT signal which can be transmitted via LAN cable. It also supports Bidirectional Infrared control signal together with the HDMI signal, so you can control the Source in the Sink side at 230ft outside, also you can control the Sink in the Source side at 230ft outside by using the HDMI Extender.

2. Features

- ✧ HDMI 2.0b (18Gbps), HDCP 2.2 and DVI compliant
- ✧ Video resolutions up to 4K2K@50/60Hz (YUV444)
- ✧ 10bits HDR (High Dynamic Range) pass through
- ✧ Supports HDMI High Bit Rate(HBR) audio pass through
- ✧ Supports CEC bypass
- ✧ Optical audio supports LPCM 2CH, Dolby Digital 2/5.1CH, DTS 2/5.1CH
- ✧ **POC (Power Over Cable)** function is supported, either TX or RX is powered by24V@1A power supply, the another does not need power supply from the DC jack. **POC** Power consumption is less than 10W.

✧ **See the description 1**
- ✧ Transfer Bidirectional Infrared control signal together with the HDMI signal.

✧ **See the description 2.**
- ✧ Transfer Bidirectional RS232 control signal together with the HDMI signal.

✧ **See the description 3.**
- ✧ Transmission distance: ✧Over CAT6 cable

70 meters: 1080P @60Hz36bit; 3D1080P@30Hz36bit;

40 meters: 1080P @60Hz@48bit; 1080P @120Hz@24bit;

3D1080P@60Hz@36bit; 4K x 2K@30Hz@24bit.

4K2K@50/60Hz (YUV420), 4K2K@50/60Hz (YUV444)

3. Package Contents

- ✧ 1 x HDMI 18Gbps Transmitter
- ✧ 1 x HDMI 18Gbps Receiver
- ✧ 2 x Wideband IR Tx
- ✧ 2 x Wideband IR Rx
- ✧ 1 x 24V/1A Power Adaptor
- ✧ 4 x Mounting brackets
- ✧ 1 x User Manual

4. Specifications

| Technical | |
|--|---|
| HDMI Compliance | HDMI 2.0b |
| HDCP Compliance | HDCP 2.2 and HDCP 1.4 |
| Video Bandwidth | 18 Gbps |
| Video Resolutions | up to 4K2K@50/60Hz(YUV4:4:4),4K2K@30Hz,1080P@120Hz, and 1080P 3D@60Hz |
| Color Space | RGB, YCbCr 4:4:4, YCbCr 4:2:2 |
| Color Depth | 10-bit, 12-bit |
| HDMI Audio Formats (Pass-through) | LPCM 2/5.1/7.1CH, Dolby Digital, DTS 5.1, Dolby Digital+, Dolby TrueHD, DTS-HD Master Audio, Dolby Atmos, DTS:X |
| Optical Audio Formats | LPCM 2CH, LPCM 5.1, Dolby Digital 2/5.1CH, DTS 2/5.1CH |
| ESD Protection | Human body model — ±8kV (air-gap discharge) & ±4kV (contact discharge) |

| Connections | |
|------------------------------|--|
| Inputs | <p>Transmitter :1x HDMI Type A [19-pin female]</p> <p>1x IR INPUT [3.5mm Stereo Mini-jack]</p> <p>1x RS232 [Phoenix jack]</p> <p>1x Service [Mini-USB jack]</p> <p>Receiver: 1x HDBaseT In [RJ45]</p> <p>1x IR INPUT [3.5mm Stereo Mini-jack]</p> <p>1x RS232 [Phoenix jack]</p> <p>1x Service [Mini-USB jack]</p> |
| Outputs | <p>Transmitter : 1x HDBaseT Out [RJ45]</p> <p>1x IR OUTPUT [3.5mm Stereo Mini-jack]</p> <p>Receiver: 1x HDMI Type A [19-pin female]</p> <p>1x IR INPUT [3.5mm Stereo Mini-jack]</p> |
| Mechanical | |
| Housing | Metal Enclosure |
| Color | Black |
| Dimensions | 157mm [W] x90mm [D] x 20mm [H] |
| Weight | 333g |
| Power Supply | Input: AC100 - 240V 50/60Hz Output: DC 24V/1A (US/EU standards, CE/FCC/UL certified) |
| Power Consumption | 24W (Max) |
| Operation Temperature | 32 - 104°F / 0 - 40°C |
| Storage temperature | -4 - 140°F / -20 - 60°C |
| Relative Humidity | 20 - 90% RH (no condensation) |

5. Operation Controls and Functions

5.1 Transmitter

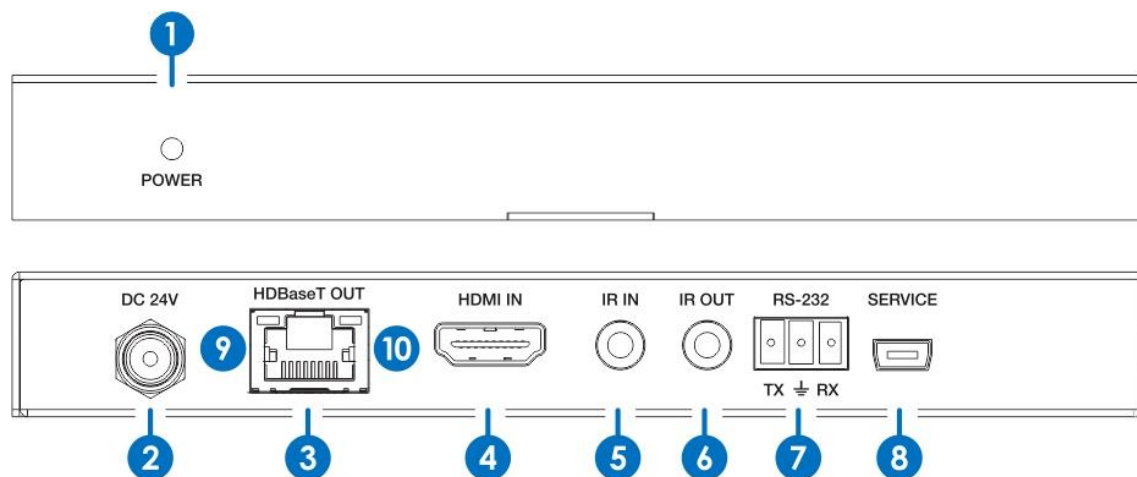

- 1 **Power LED:** System power indicator.
- 2 **DC 24V:** Connect 24V/1A adaptor to AC wall outlet for power supply.
- 3 **HDBaseT Out:** Standard HDBaseT signal output port. Connect HD BaseT receiver with a UTP cable following the standard of direct interconnection method
- 4 **HDMI In:** Connect this to HDMI source devices such as Blu-ray or PS4 player
- 5 **IR In:** Channel 2 IR Receiver. Connect with Wideband IR Rx.
- 6 **IR Out:** Channel 1 IR Transmitter. Connect with Wideband IR Tx.
- 7 **RS-232:** Phoenix jack provide Serial port control signal from receiver or to receiver.
- 8 **Service:** Manufacturer use only.
- 9 **Connection Signal Indicator Lamp**

※Illuminate: The Transmitter and Receiver are in good connections status.

※Flashing: The Transmitter and Receiver are in poor connections status.

※Dark: The Transmitter and Receiver are not connected.

10 Data Signal Indicator Lamp

※Illuminate: The HDMI signal with HDCP.

※Flashing: The HDMI signal without HDCP.

※Dark: No HDMI signal.

5.2 Receiver

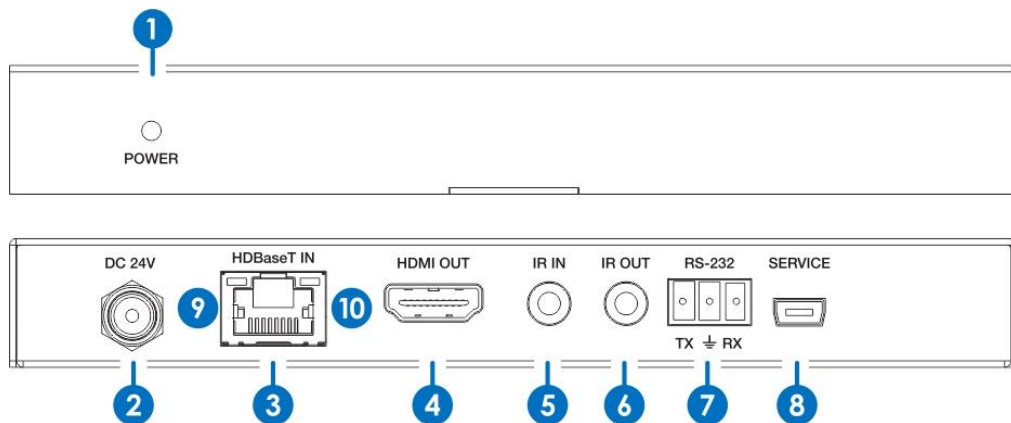

- 1 Power LED:** System power indicator.
- 2 DC 24V:** Connect 24V/1A adaptor to AC wall outlet for power supply.
- 3 HDBaseT In:** Standard HDBaseT signal input port. Connect HD BaseT Transmitter with a UTP cable following the standard of direct interconnection method
- 4 HDMI Out:** HDMI output port. This slot is where you connect the HDTV or monitor with HDMI cable.
- 5 IR In:** Channel 1 IR Receiver. Connect with Wideband IR Rx

6 IR Out: Channel 2 IR Transmitter. Connect with Wideband IR Tx.

7 RS-232: Phoenix jack provide Serial port control signal from receiver or to receiver.

8 Service: Manufacturer use only.

9 Connection Signal Indicator Lamp

※Illuminate: The Transmitter and Receiver are in good connections status.

※Flashing: The Transmitter and Receiver are in poor connections status.

※Dark: The Transmitter and Receiver are not connected.

10 Data Signal Indicator Lamp

※Illuminate: The HDMI signal with HDCP.

※Flashing: The HDMI signal without HDCP.

※Dark: No HDMI signal.

※ Description 1

POC (Power Over Cable) Application Example

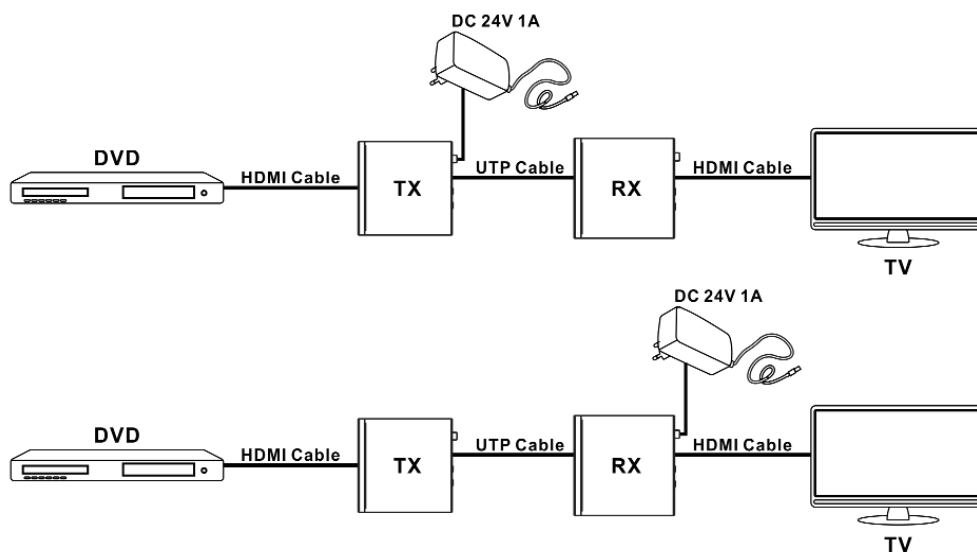

※ Description 2

Bidirectional Infrared control Application Example

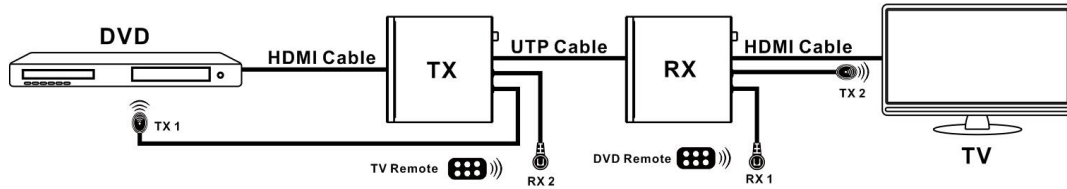

※ Description 3

Bidirectional RS232 control Application Example

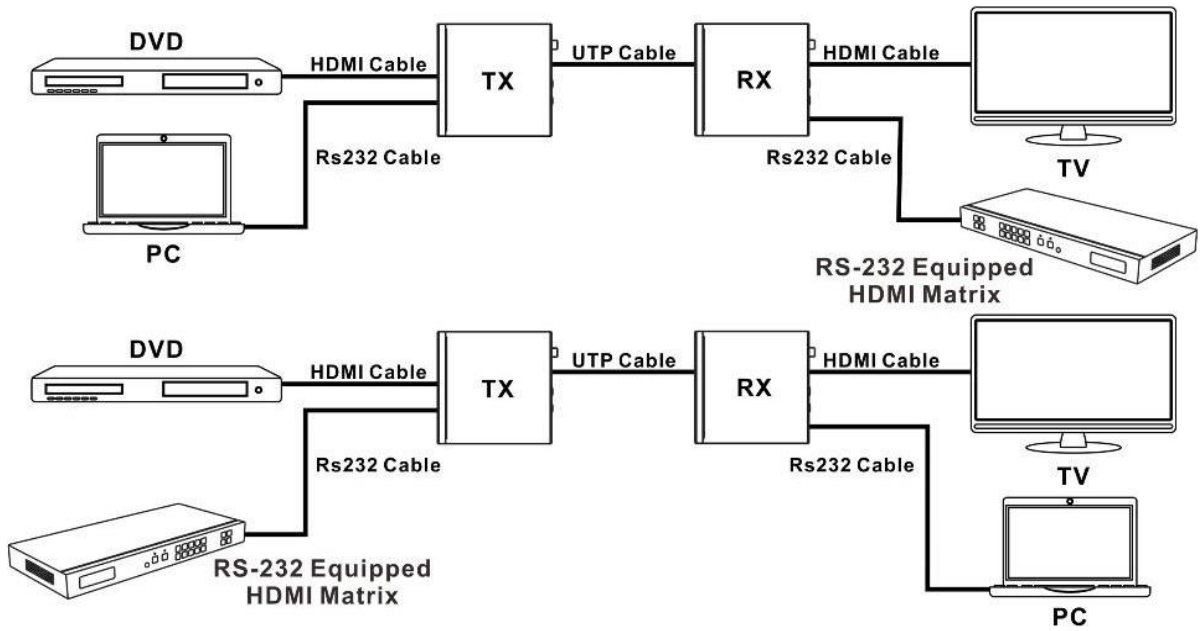

6. Connection Diagram

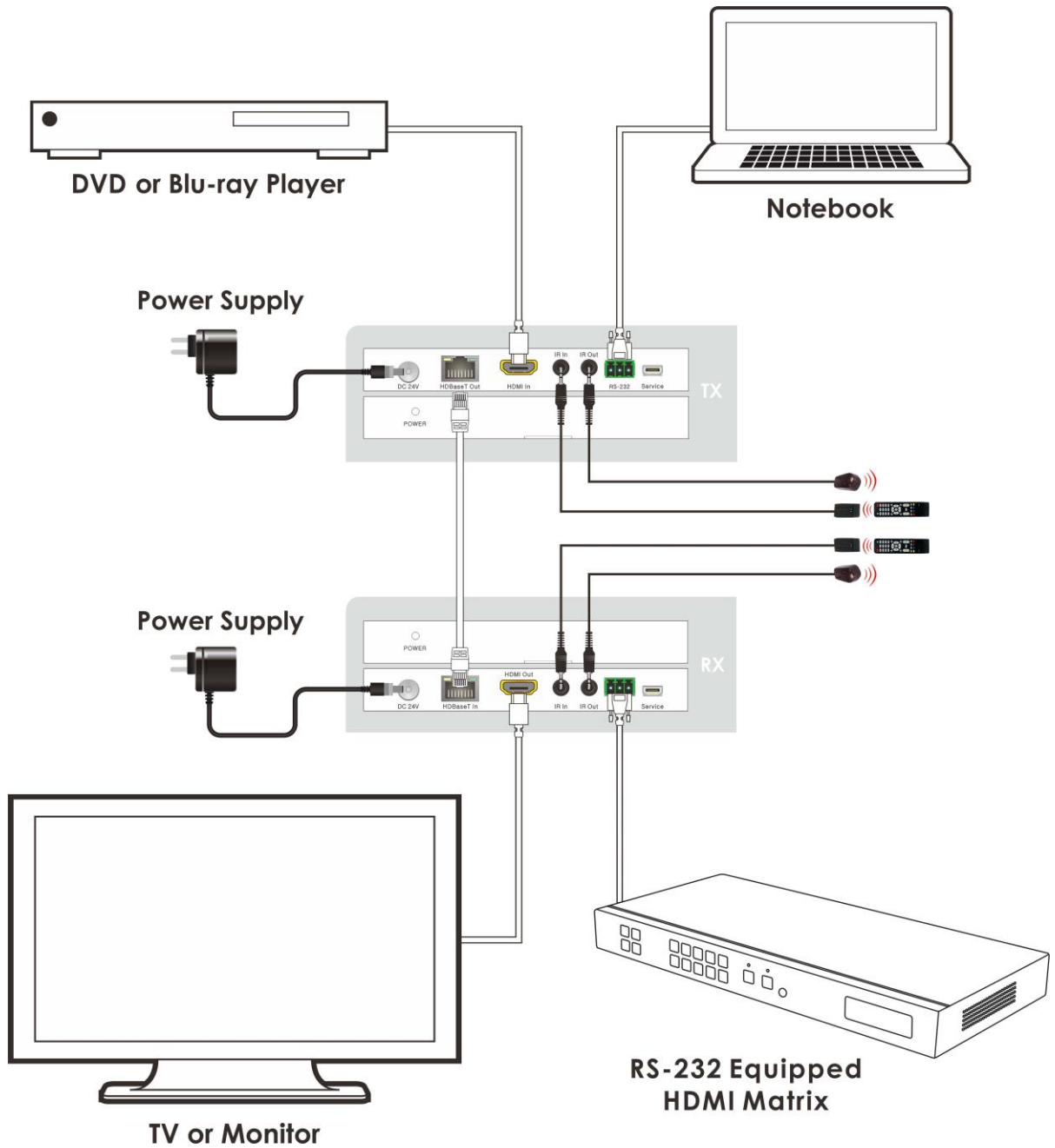

The Pro's Connectivity Since 1974

80 Little Falls Road, Fairfield, NJ 07004

sales@comprehensiveco.com | 800.526.0242 | www.ComprehensiveCo.com